

INTERCONNECTION

Earth A

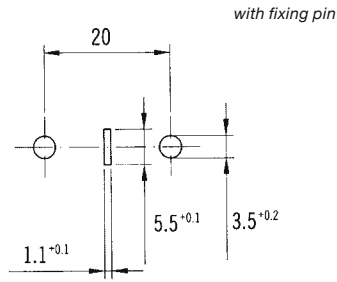

Earth B

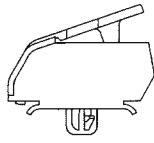
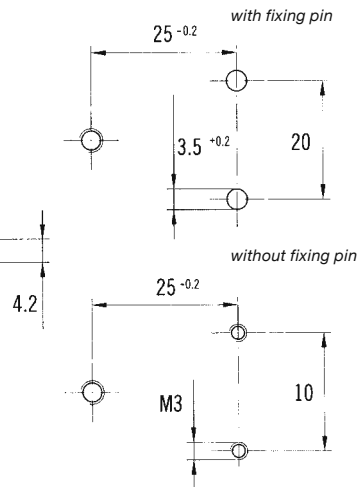
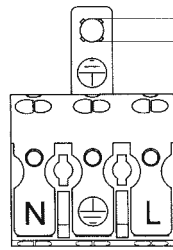

Earth C

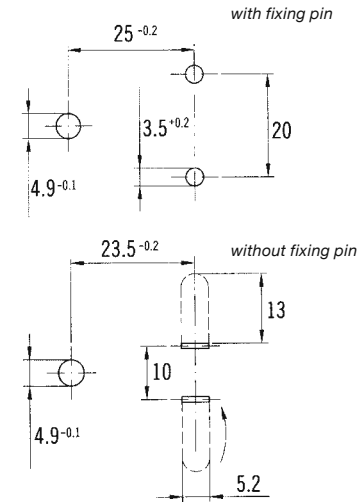
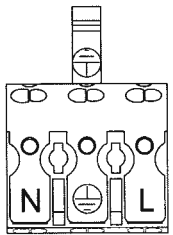
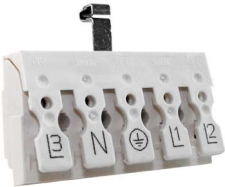

Strain Relief

- To clamp installation cables
- Easy fitting

TYPE NO. FAST CONNECTOR

CSR6 CPW

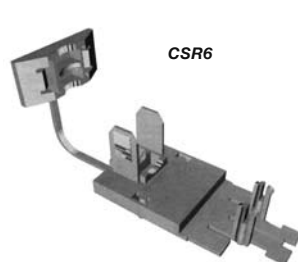

CSR6

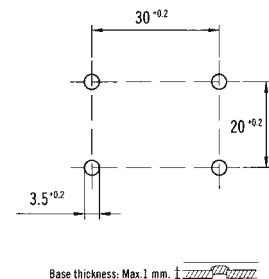
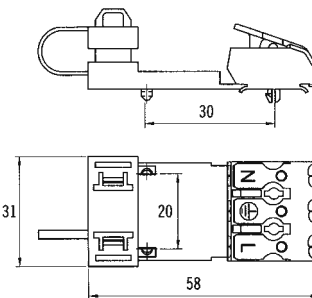

PCB
TERMINAL
BLOCKS

INTER-
CONNECTION

FUSES &
FUSE-
HOLDERS

LEDs &
INDICATORS

MINIATURE
SWITCHES

LIMIT &
SAFETY
SWITCHES

CONTROL
PRODUCTS

INTERFACE
MODULES &
SUPPORTS

RELAY
BASES

ENCLOSURES

BATTERIES

TRANS-
FORMERS



We operate a constant improvement policy,
our products are subject to change without notice.