

SPECIFICATIONS:

CONTACT RATING: Refer to "Contact Material Options" for more info.
ELECTRICAL LIFE: 50,000 make-and-break cycles at full load.
CONTACT RESISTANCE: 10mΩ max. initial @2-4VDC
 100mA for both silver and gold plated contacts.
INSULATION RESISTANCE: 1,000 MΩ min.
DIELECTRIC STRENGTH: 1,500V RMS @ sea level.
OPERATING TEMPERATURE: -30°C to 85°C

MATERIALS:

CASE: Diallyl phthalate(DAP)(UL 94V-0)
TOGGLE HANDLE: Brass, chrome plated.
BUSHING: Brass, nickel plated.
HOUSING: Stainless Steel.
TERMINAL SEAL: Epoxy.

If your preferred product configuration is not shown, please contact our sales representative for custom design.

HOW TO ORDER SYSTEM

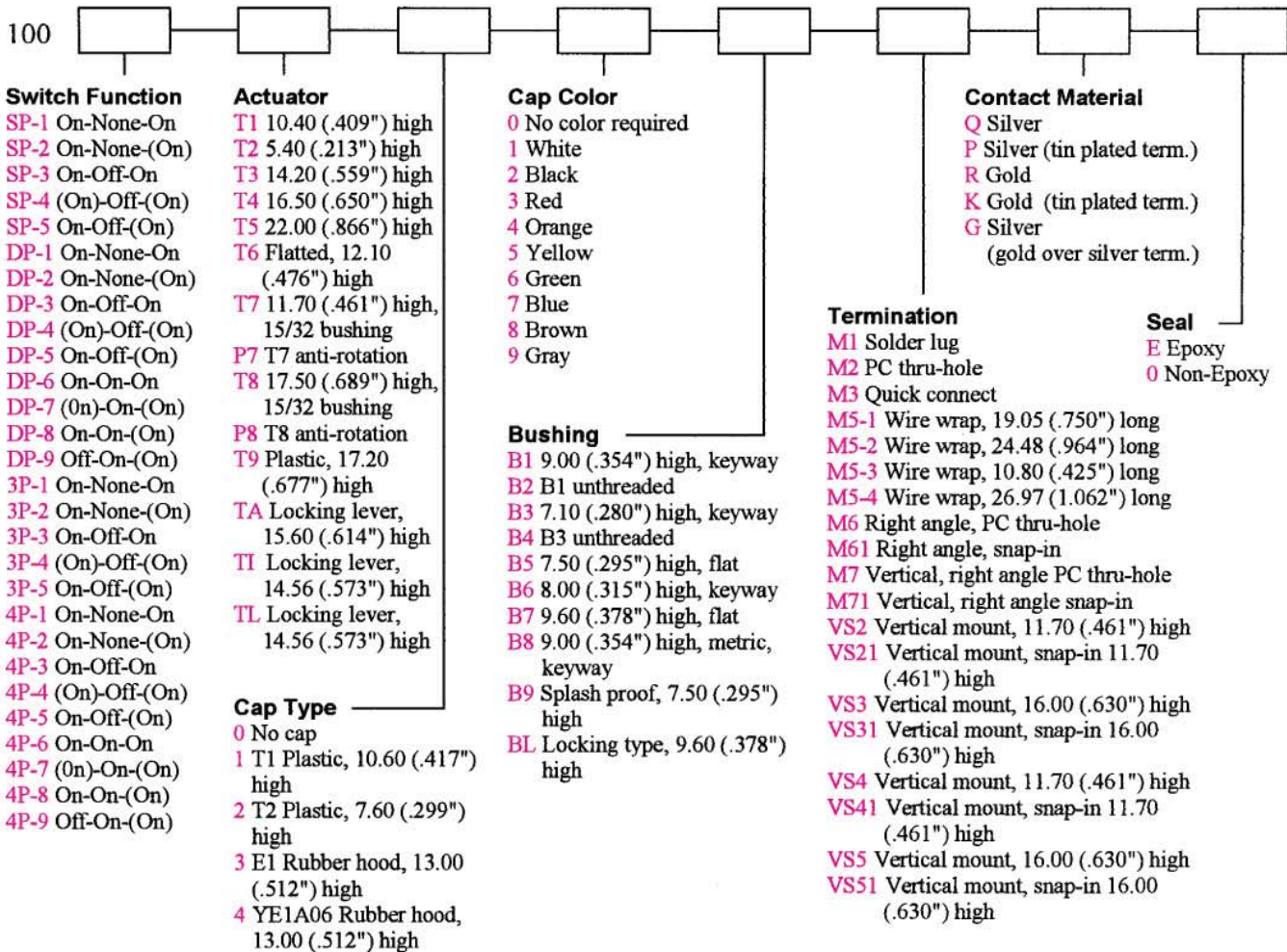

Note:
 No cap type required for T9 actuator

Specifications and Dimensions subject to change

SPDT



Model No.	Switching Position		
SP-1	ON	NONE	ON
SP-2	ON	NONE	(ON)
SP-3	ON	OFF	ON
SP-4	(ON)	OFF	(ON)
SP-5	ON	OFF	(ON)
Term. Comm.	2-3	OPEN	2-1

Schematic O2Comm.

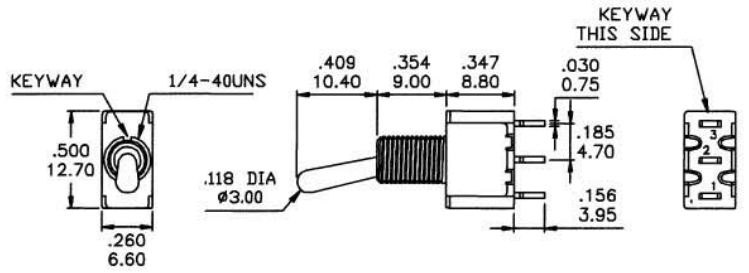

DPDT



Model No.	Switching Position		
DP-1	ON	NONE	ON
DP-2	ON	NONE	(ON)
DP-3	ON	OFF	ON
DP-4	(ON)	OFF	(ON)
DP-5	ON	OFF	(ON)
Term. Comm.	2-3,5-6	OPEN	2-1,5-4

Schematic O2Comm. O5Comm.

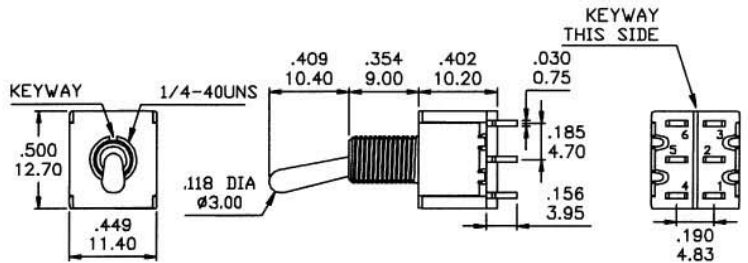

WIRING FOR ON-ON-ON (3-WAY) FUNCTION

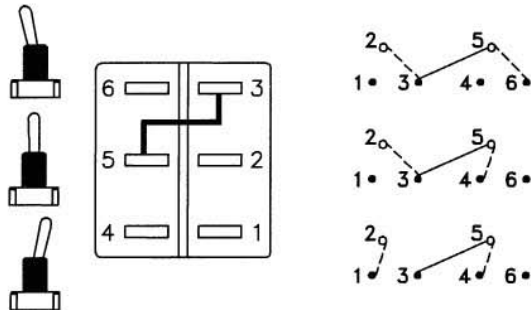

3PDT



Model No.	Switching Position		
3P-1	ON	NONE	ON
3P-2	ON	NONE	(ON)
3P-3	ON	OFF	ON
3P-4	(ON)	OFF	(ON)
3P-5	ON	OFF	(ON)
Term. Comm.	2-3,5-6 8-9	OPEN	2-1,5-4 8-7

Schematic O2Comm. O5Comm. O8Comm.

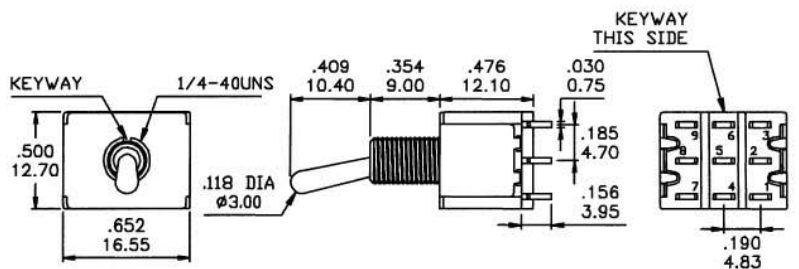

4PDT



Model No.	Switching Position		
4P-1	ON	NONE	ON
4P-2	ON	NONE	(ON)
4P-3	ON	OFF	ON
4P-4	(ON)	OFF	(ON)
4P-5	ON	OFF	(ON)
Term. Comm.	2-3,5-6 8-9 11-12	OPPEN	2-1,5-4 8-7 11-10

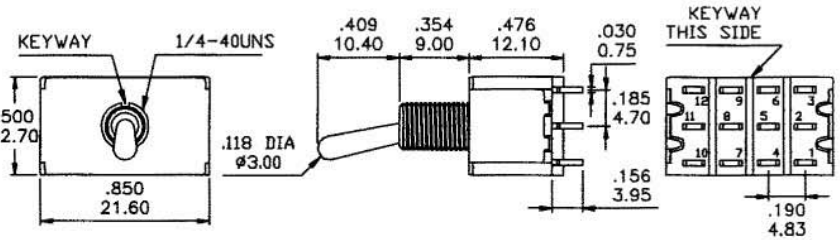

Model No.	Switching Position		
4P-6	ON	ON	ON
4P-7	(ON)	ON	(ON)
4P-8	ON	ON	(ON)
4P-9	OFF	ON	(ON)
Term. Comm.	2-3,5-6 8-9 11-12	2-3,5-4 8-9 11-10	2-1,5-4 8-7 11-10

WIRING FOR ON-ON-ON (3-WAY) FUNCTION

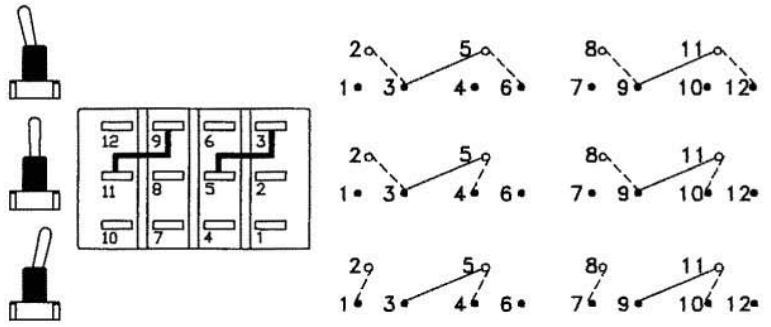

Schematic

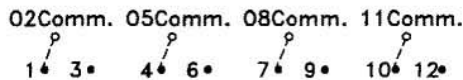

ACTUATOR OPTIONS

T1 STD

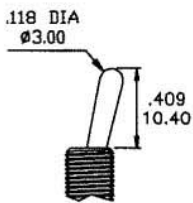

T2

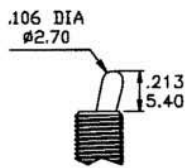

T3

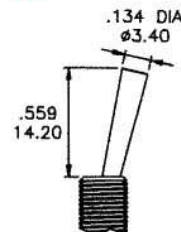

T4

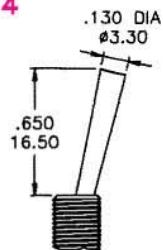

T5

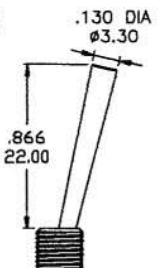

T6

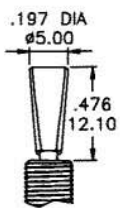

T7 P7 ANTI-ROTATION

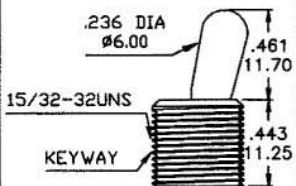

T8 P8 ANTI-ROTATION

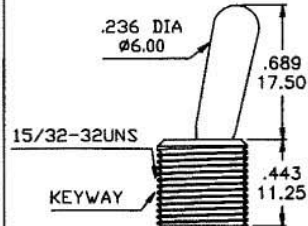

T9 PLASTIC

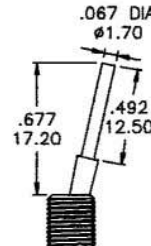

NO. COLOR

- 1 White
- 2 Black(std.)
- 3 Red
- 4 Orange
- 5 Yellow
- 6 Green
- 7 Blue
- 8 Brown
- 9 Gray

T0

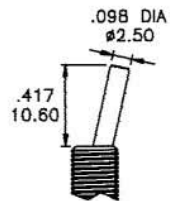

LOCKING LEVER

TA

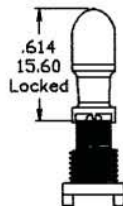
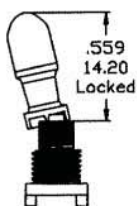

FOR SP-1,DP-1
3P-1,4P-1 ONLY

FOR SP-3,DP-3
3P-3,4P-3 ONLY

LOCKING LEVER

TI

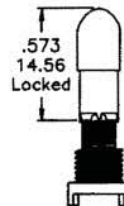
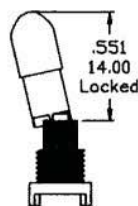

FOR SP-1,DP-1
3P-1,4P-1 ONLY

FOR SP-3,DP-3
3P-3,4P-3 ONLY

LOCKING LEVER

TL

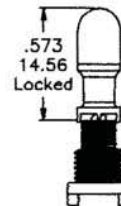
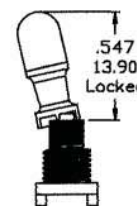

FOR SP-1,DP-1
3P-1,4P-1 ONLY

FOR SP-3,DP-3
3P-3,4P-3 ONLY

* T6 must configure with a stand-off bushing.

* For T7,P7,T8,P8 bushing code is not required.

* Actuator length shown for T1 ~ T5 and T9 ~ T0 is with B1 bushing.

BUSHING OPTIONS

<p>B1 THD STD. B2 NON-THD</p>	<p>B3 THD B4 NON-THD</p>	<p>B5 HIGH TORQUE</p>	<p>B6 HIGH TORQUE</p>
<p>B7 LONG</p>	<p>B8 METRIC</p>	<p>B9 SPLASH-PROOF</p>	<p>BL LOCKING LEVER</p>
<p>BA THD STD. (T6)</p>		<p>BB NON-THD (T6)</p>	<p>BE HIGH TORQUE (T6)</p>

PANEL MOUNTING

<p>1/4 INCH BUSHING</p>	<p>15/32 INCH BUSHING</p>
--------------------------------	----------------------------------

TERMINATION OPTIONS

<p>M1 STD. SOLDER LUG</p>	<p>M2 PC THRU-HOLE</p>	<p>M3 QUICK CONNECT</p>	<p>M5 WIRE WRAP</p> <table border="1" data-bbox="1300 1803 1556 2038"> <thead> <tr> <th>OPTION CODE</th> <th>DIM. 'A'</th> </tr> </thead> <tbody> <tr> <td>M5-1</td> <td>.750(19.05)</td> </tr> <tr> <td>M5-2</td> <td>.964(24.48)</td> </tr> <tr> <td>M5-3</td> <td>.425(10.80)</td> </tr> <tr> <td>M5-4</td> <td>1.062(26.97)</td> </tr> </tbody> </table>	OPTION CODE	DIM. 'A'	M5-1	.750(19.05)	M5-2	.964(24.48)	M5-3	.425(10.80)	M5-4	1.062(26.97)
OPTION CODE	DIM. 'A'												
M5-1	.750(19.05)												
M5-2	.964(24.48)												
M5-3	.425(10.80)												
M5-4	1.062(26.97)												

TERMINATION OPTIONS

M6

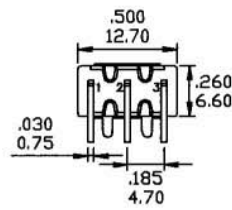
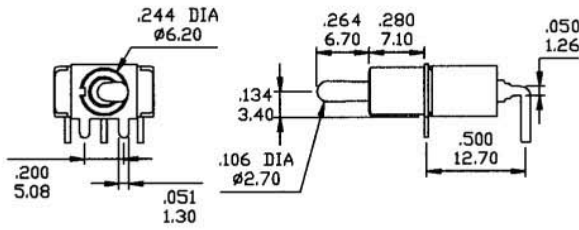

P.C.MOUNTING

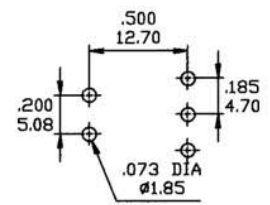

SPDT

M6

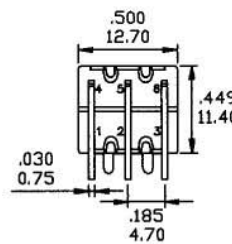
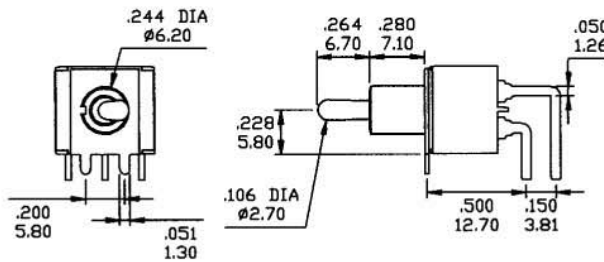

P.C.MOUNTING

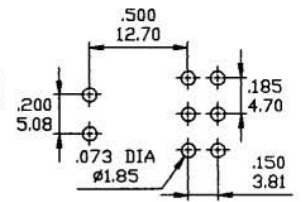

DPDT

M6

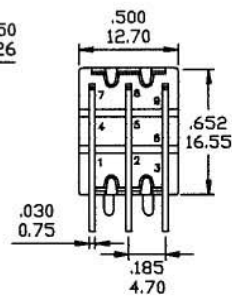
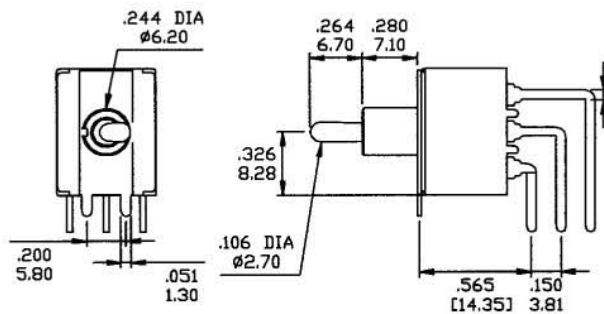

P.C.MOUNTING

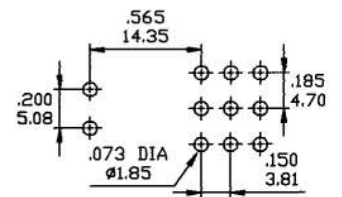

3PDT

M7

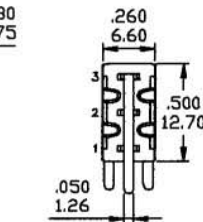
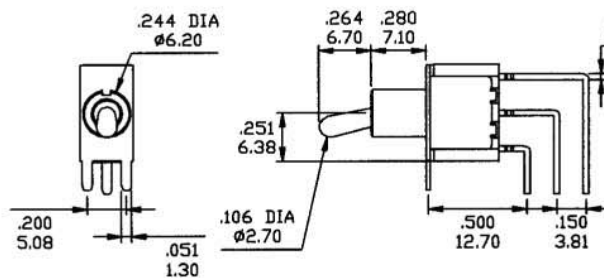

P.C.MOUNTING

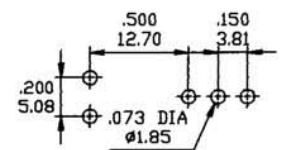

SPDT

M7

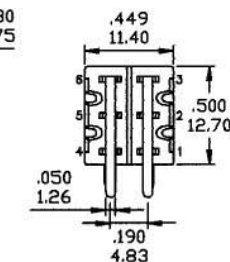
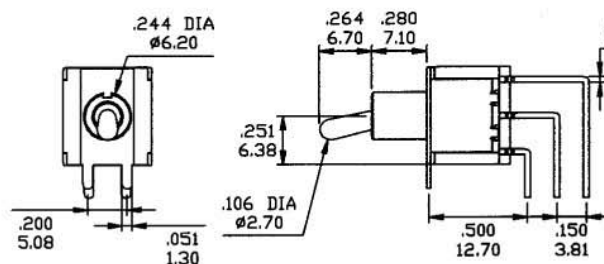

P.C.MOUNTING

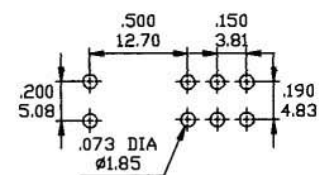

DPDT

TERMINATION OPTIONS

M7

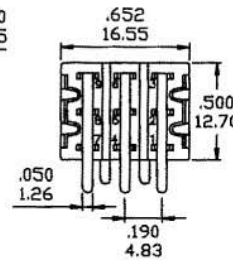
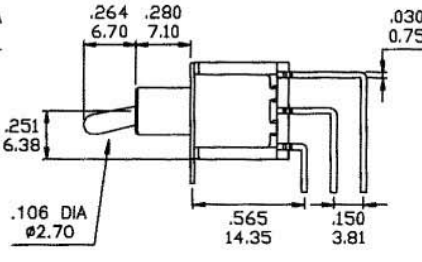
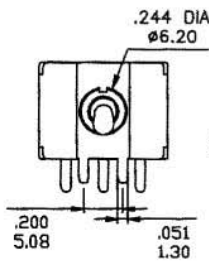

P.C.MOUNTING

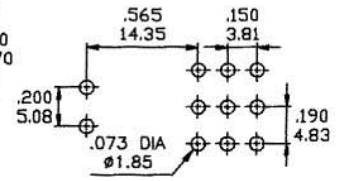

3PDT

M7

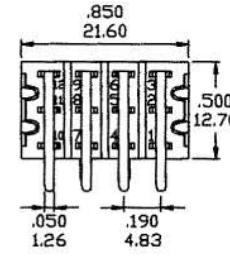
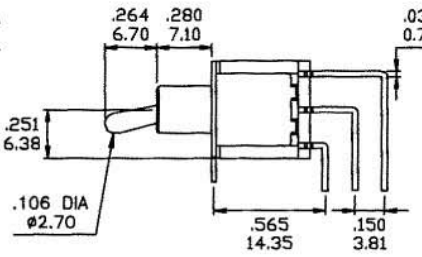
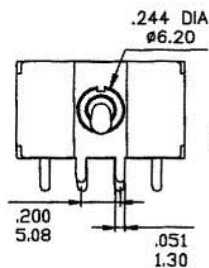

P.C.MOUNTING

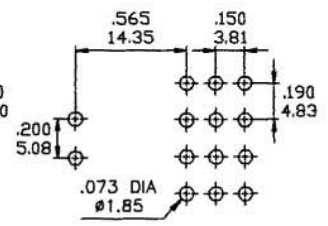

4PDT

VS2-VS3

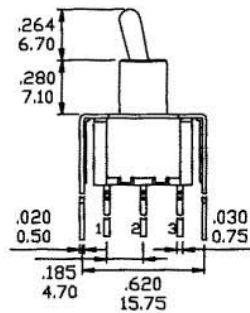
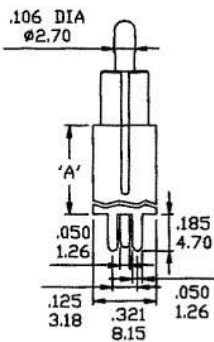

OPTION CODE	DIM. 'A'
VS2	.461 11.70
VS3	.630 16.00

P.C.MOUNTING

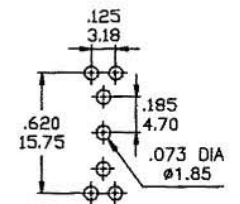

SPDT

VS2-VS3

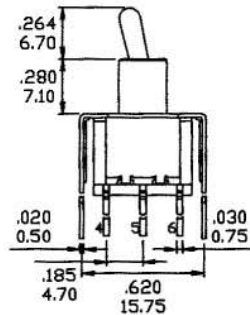
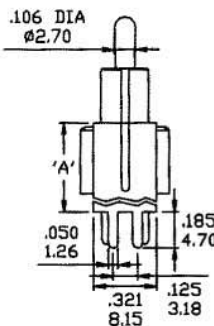

OPTION CODE	DIM. 'A'
VS2	.461 11.70
VS3	.630 16.00

P.C.MOUNTING

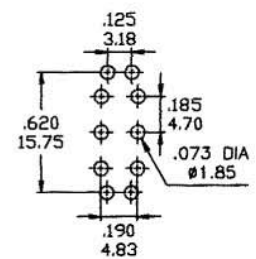

DPDT

VS4-VS5

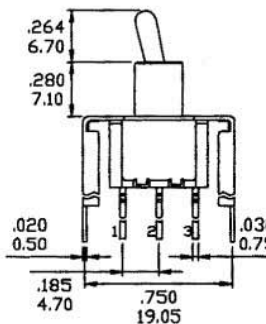
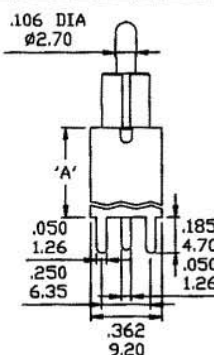

OPTION CODE	DIM. 'A'
VS4	.461 11.70
VS5	.630 16.00

P.C.MOUNTING

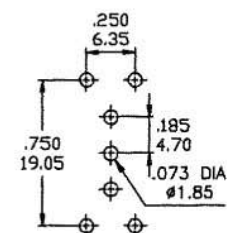

SPDT

TERMINATION OPTIONS

VS4-VS5

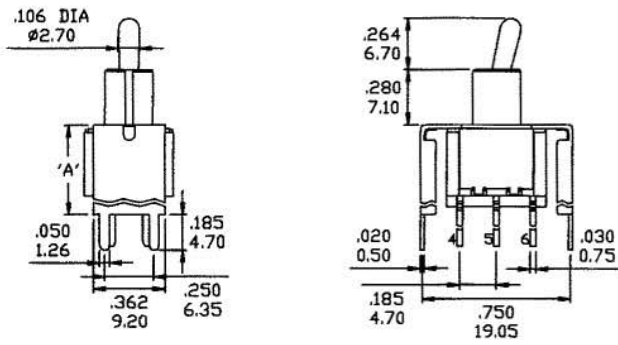

OPTION CODE	DIM. 'A'
VS4	.461 11.70
VS5	.630 16.00

P.C.MOUNTING

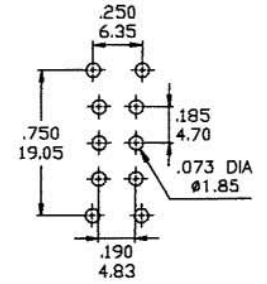

DPDT

SNAP-IN TERMINATION OPTIONS

M61 (AVAILABLE WITH SPDT AND DPDT)

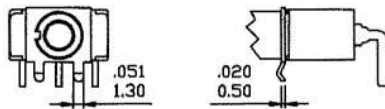

VS21,VS31

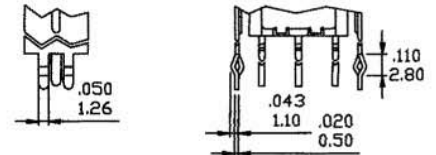

M71 (AVAILABLE WITH SPDT AND DPDT)

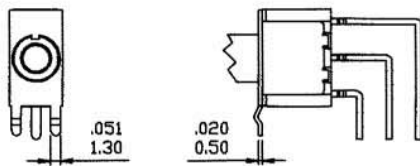

VS41,VS51

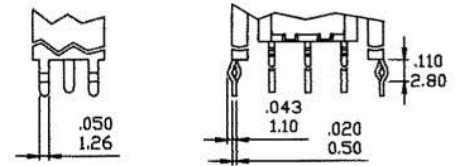

* PC Mounting for M61,M71,VS21,VS31,VS41,VS51 refer to M6,M7,VS2,VS3,VS4,VS5 respectively.

HARDWARE

NUT

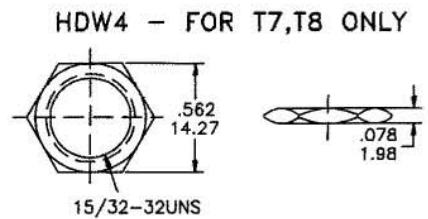
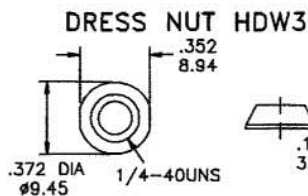
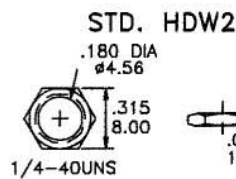

LOCKING RING

LOCK WASHER

STD. HDW15

STD. HDW16

HDW17 - FOR T7,T8 ONLY

STD. HDW11 HDW12 - FOR T7,T8 ONLY

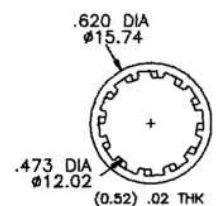
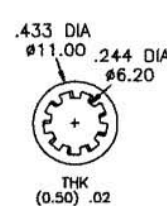
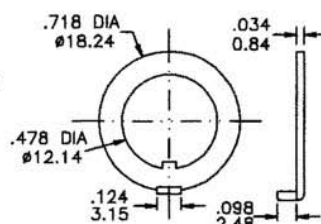
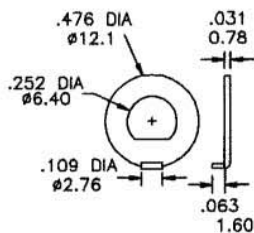
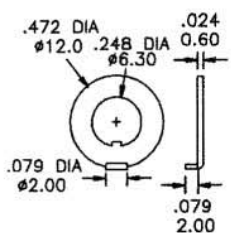

TOGGLE CAPS

T1 ACTUATOR CAP



* MATERIAL: PVC.

T2 ACTUATOR CAP



* MATERIAL: PVC.

T9 ACTUATOR GLOSS PLASTIC

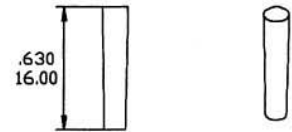

* MATERIAL: ABS.

E1 RUBBER HOOD

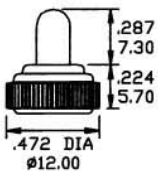

E1=INCH (STD.)
E1A=INCH WITH INTERNAL-ORING SEALED
K1=METRIC M6P0.75 THD (For B8 bushing only)

* FOR T1 ACTUATOR ONLY.

YE1A06 RUBBER HOOD

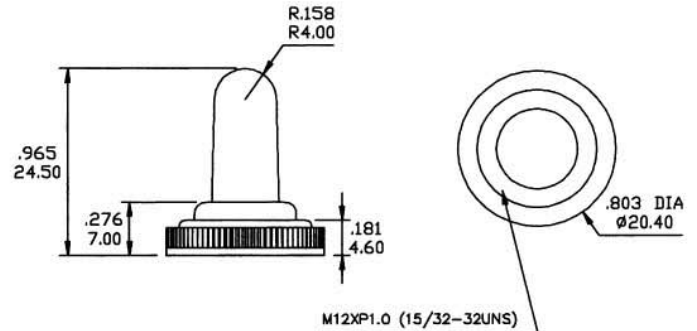

* FOR T8 ACTUATOR ONLY.

CONTACT MATERIAL OPTIONS

Coding	Contact Material	Terminal Plating	Rating	Agency Approvals
Q	Silver ¹	Silver plated ¹	5Amps @ 125VAC or 28VDC 2Amps @ 250VAC	
P		Tin plated ⁵ ⁷		
R	Gold ²	Gold plated ⁴	0.4VA max @ 20V max (AC or DC)	
K		Tin plated ⁵ ⁶		
G	Silver ¹	Gold over ³ silver	5Amps @ 125VAC or 28VDC 2Amps @ 250VAC	

1. Movable Contact / Terminals: Copper alloy, silver plated.
2. Movable Contact: Copper alloy with gold plated over nickel plated.
3. Terminals: Silver plated with outer layer in gold plating.
4. Terminals: Copper alloy, with gold plated over nickel plated.
5. Outer Terminals: Copper alloy with pure tin plated.
6. Terminal Contact: Gold plated over nickel plated.
7. Terminal Contact: Palladium nickel alloy (or Silver) plated.

* P, K not available with M1 and M3 terminals
 * 6Amps (Movable Contact: coin silver, silver plated) available to model ON-NONE-ON. but no agency approval when ordered.