

<p style="text-align: center;"><b>LF-SD1813B</b></p> 	
<p><b>Speaker</b></p> 	<p><b>Receiver</b></p> 
<p style="text-align: center;"><b>LF-SD1813D</b></p> 	
<p><b>Speaker</b></p> 	<p><b>Receiver</b></p> 

Part No.		Sensitivity	Input Power (nom./max.)	Impedance (Ohm)	Operating Temp. (°C)
型 號		靈敏度	可承受輸入功率	阻 抗	工作溫度
LF-SD1813B	Receiver	117 ±3dB at 1KHz.100m Vrms	0.03W/0.05W	8 ± 15%	-20°C~ +75°C
	Speaker	85 ± 3 dB at average 0.7~3 KHz 2 Vrms	0.5W/1.0W		
LF-SD1813D	Receiver	120 ±3dB at 1KHz.100m Vrms	0.01W/0.03W	8 ± 15%	-20°C~ +70°C
	Speaker	90 ± 3 dB at average 0.8~3 KHz 2 Vrms	0.5W/0.7W		

LF-SD1813E

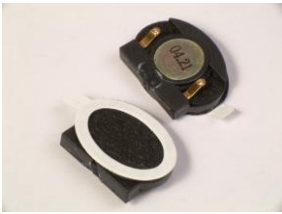
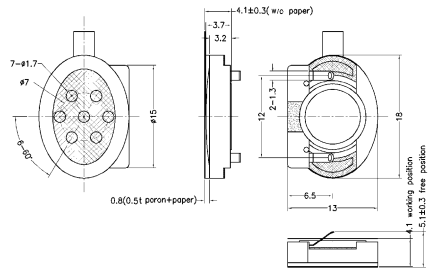
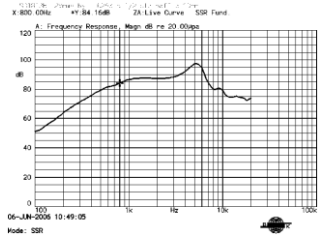
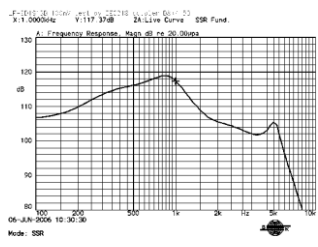
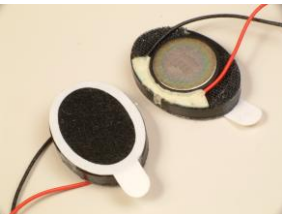
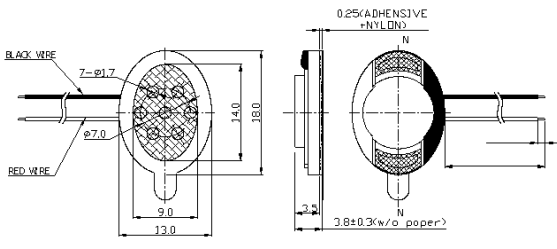
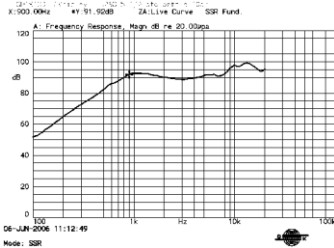
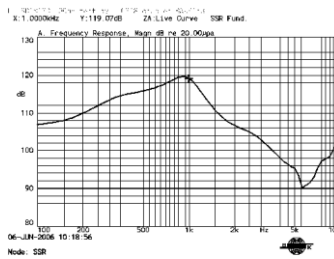
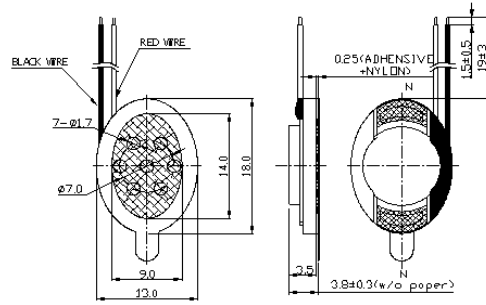
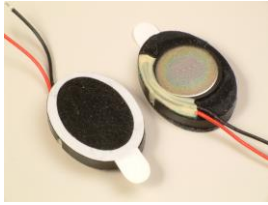

Speaker

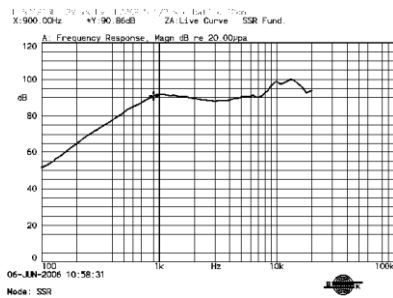

Receiver

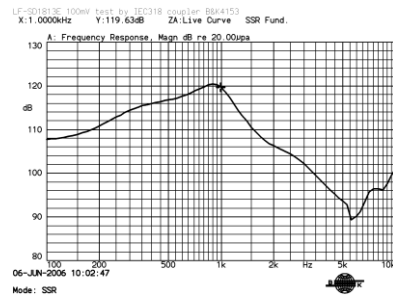

Part No. 型 號		Sensitivity 靈敏度	Input Power (nom./max.) 可承受輸入功率	Impedance (Ohm) 阻 抗	Operating Temp. (°C) 工作溫度
LF-SD1813E	Receiver	120± 3dB at 1KHz 60m Vrms	0.01W/0.03W	8 ± 15%	-20°C ~ +60°C
	Speaker	90± 3dB at average 0.8~3 KHz 2.0 Vrms	0.5W/0.7W		