

ACTUATOR OPTIONS FOR P.C MOUNT

R2

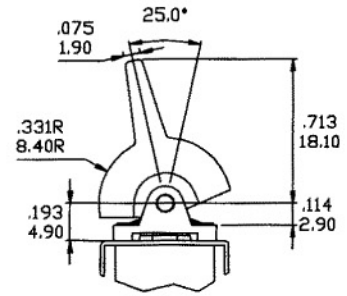

R3

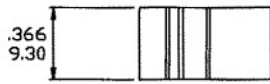
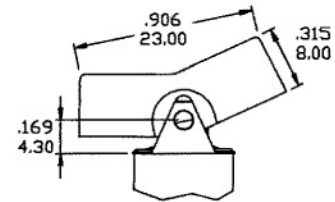
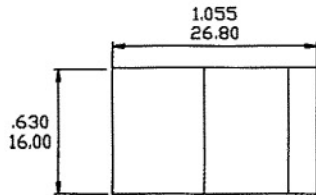

R4

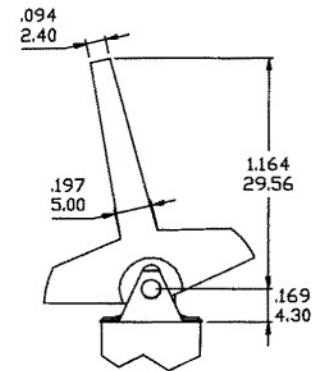
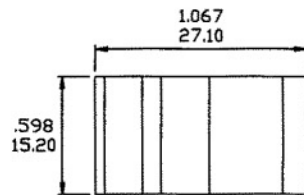

R5

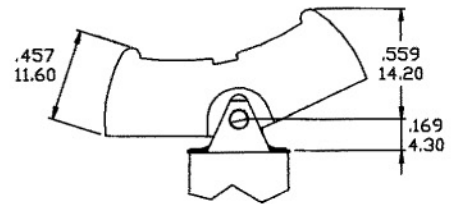
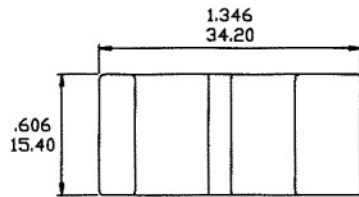

R6

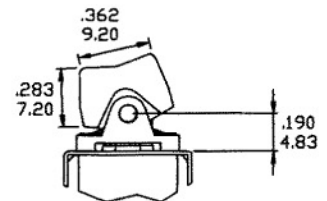
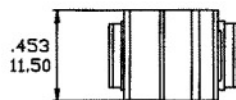

R7

